



C170E

Smart Cylinder

Ultra wide-ranging of adaptation and easy installation.



Functional Features

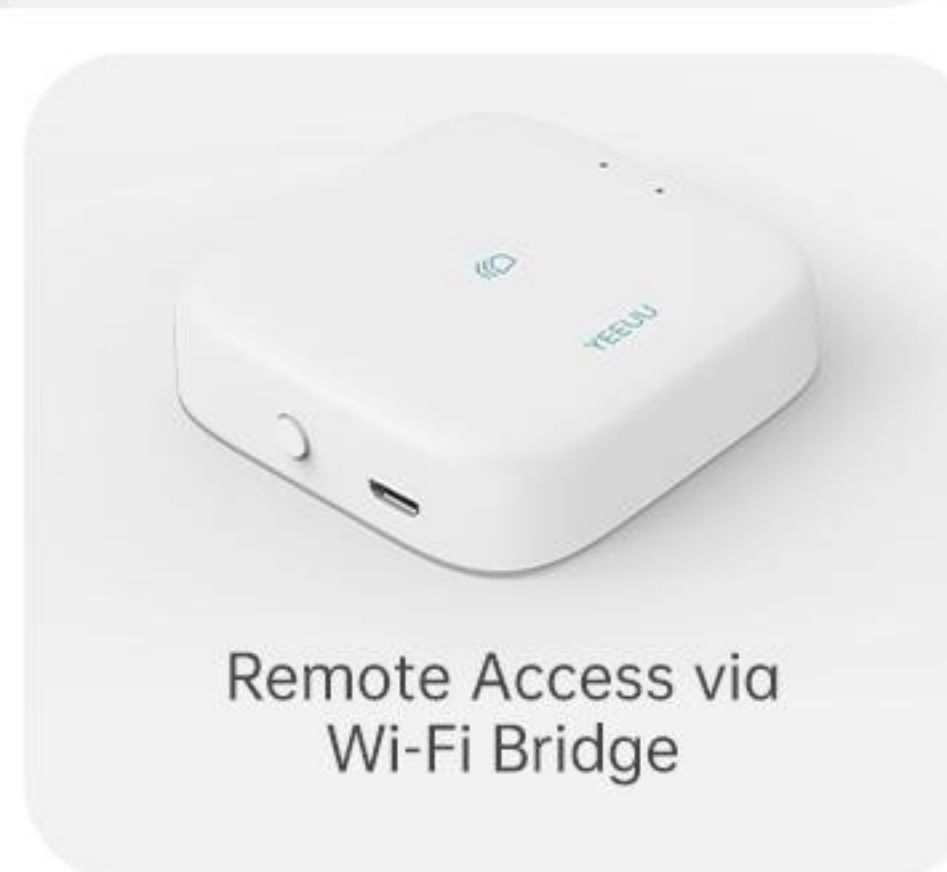
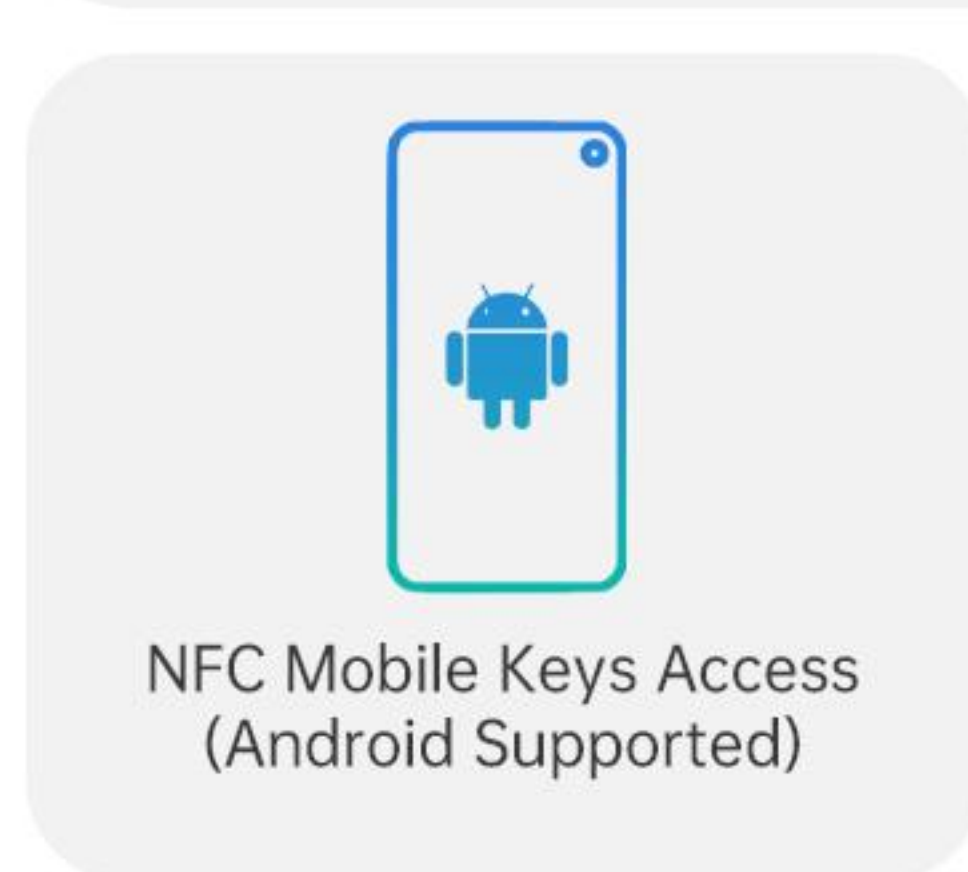
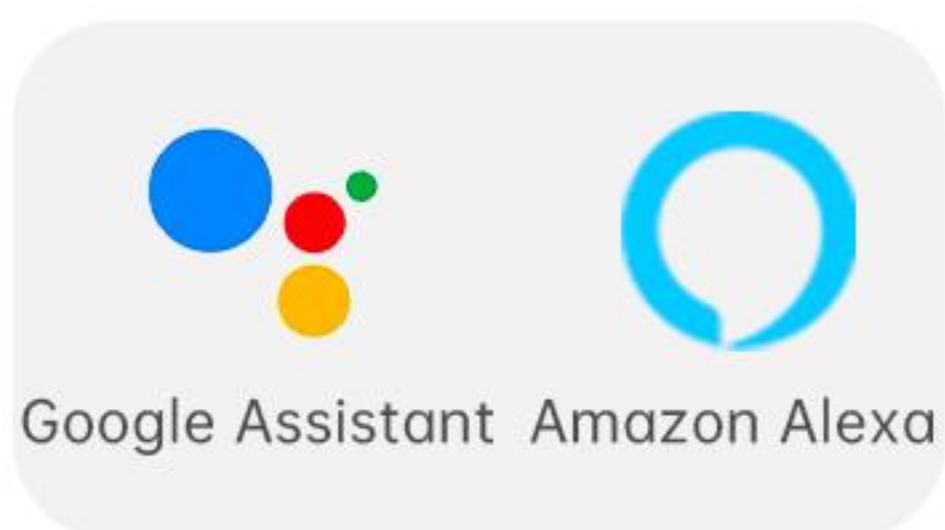
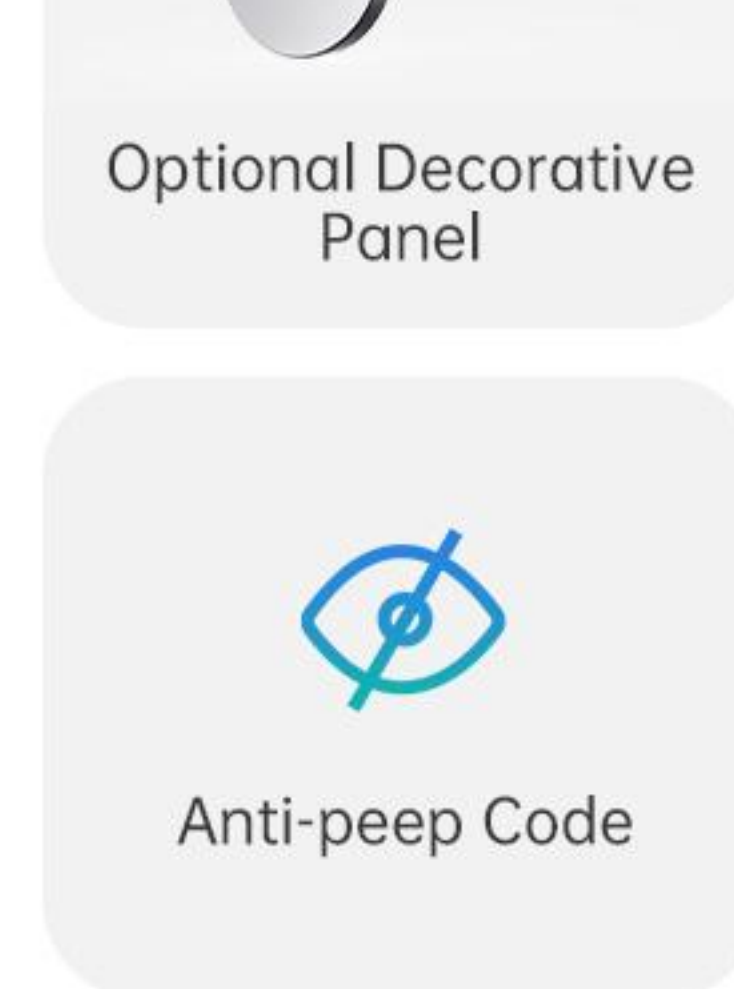
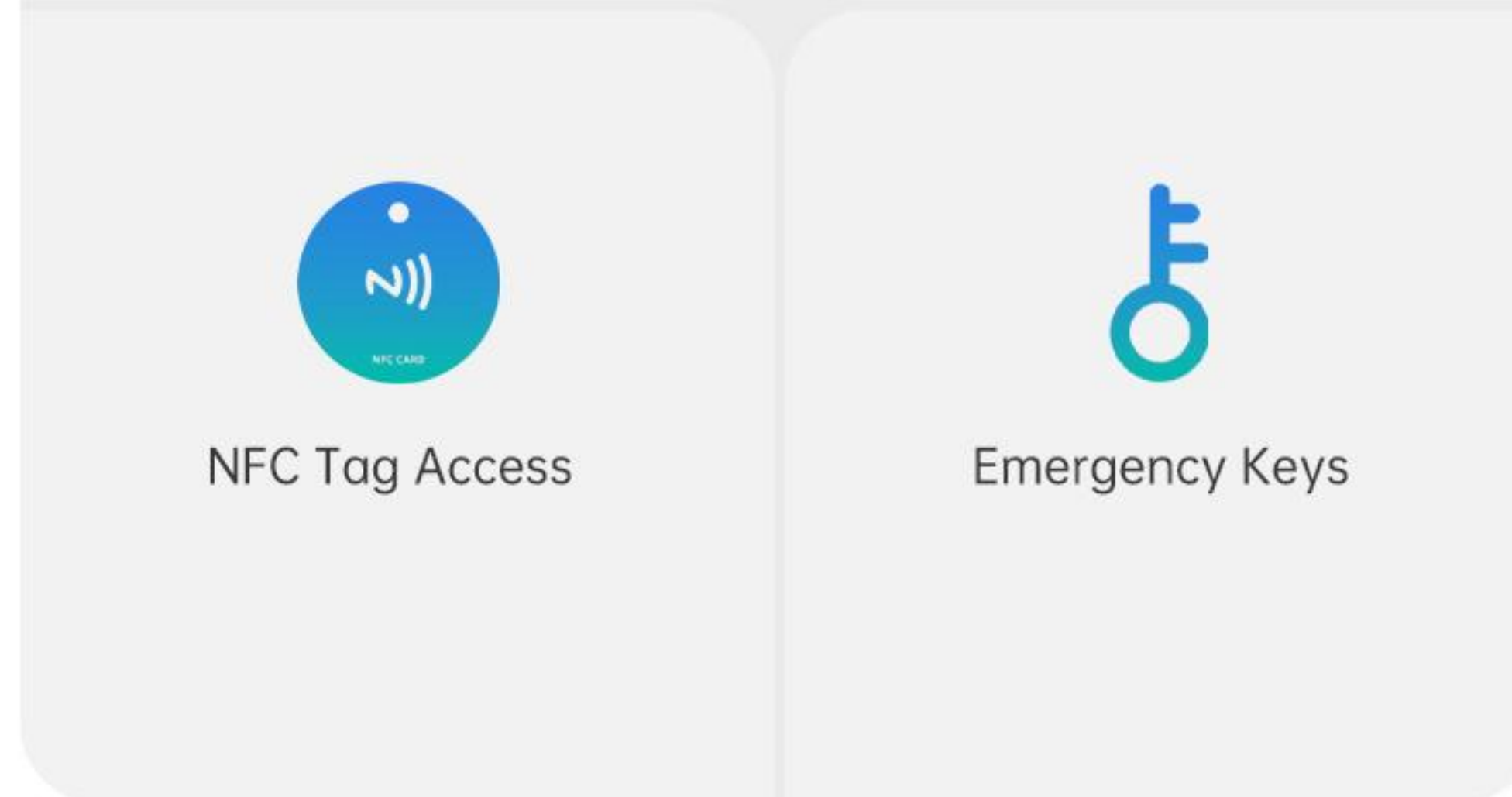
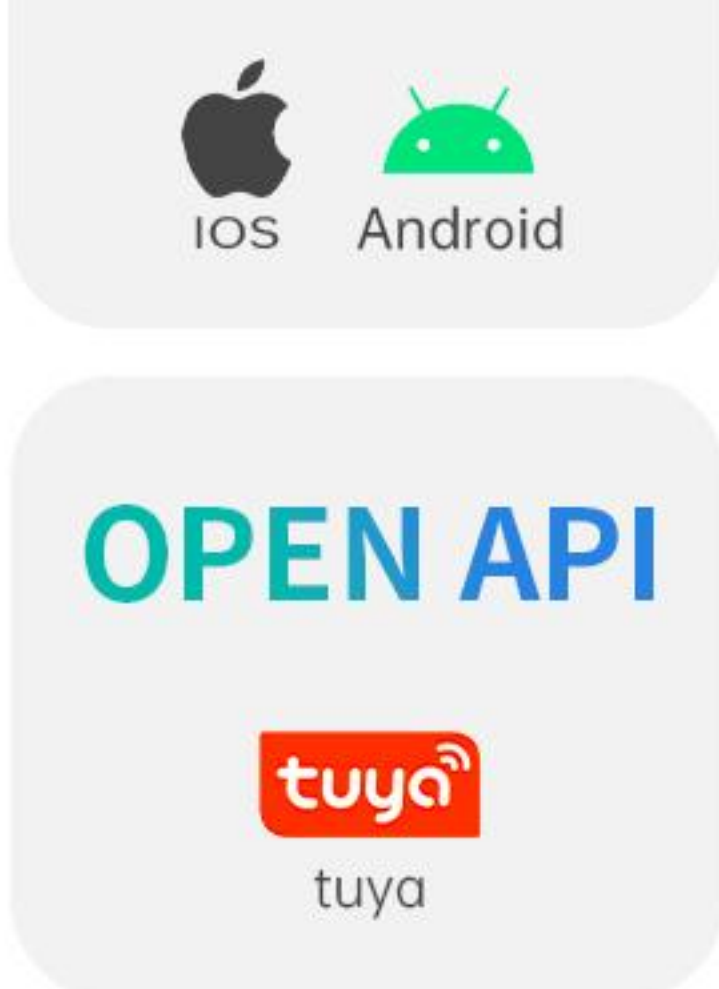
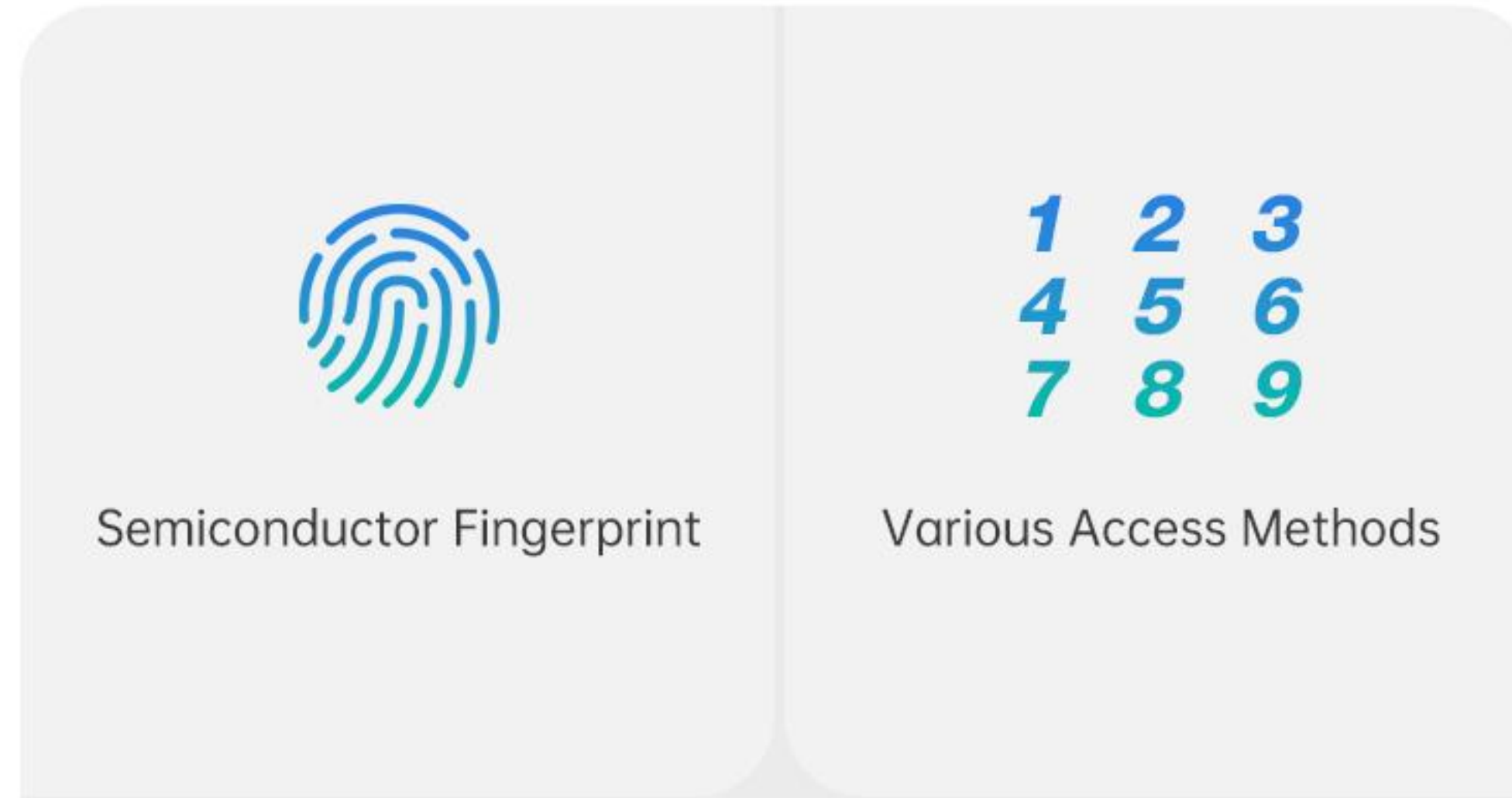
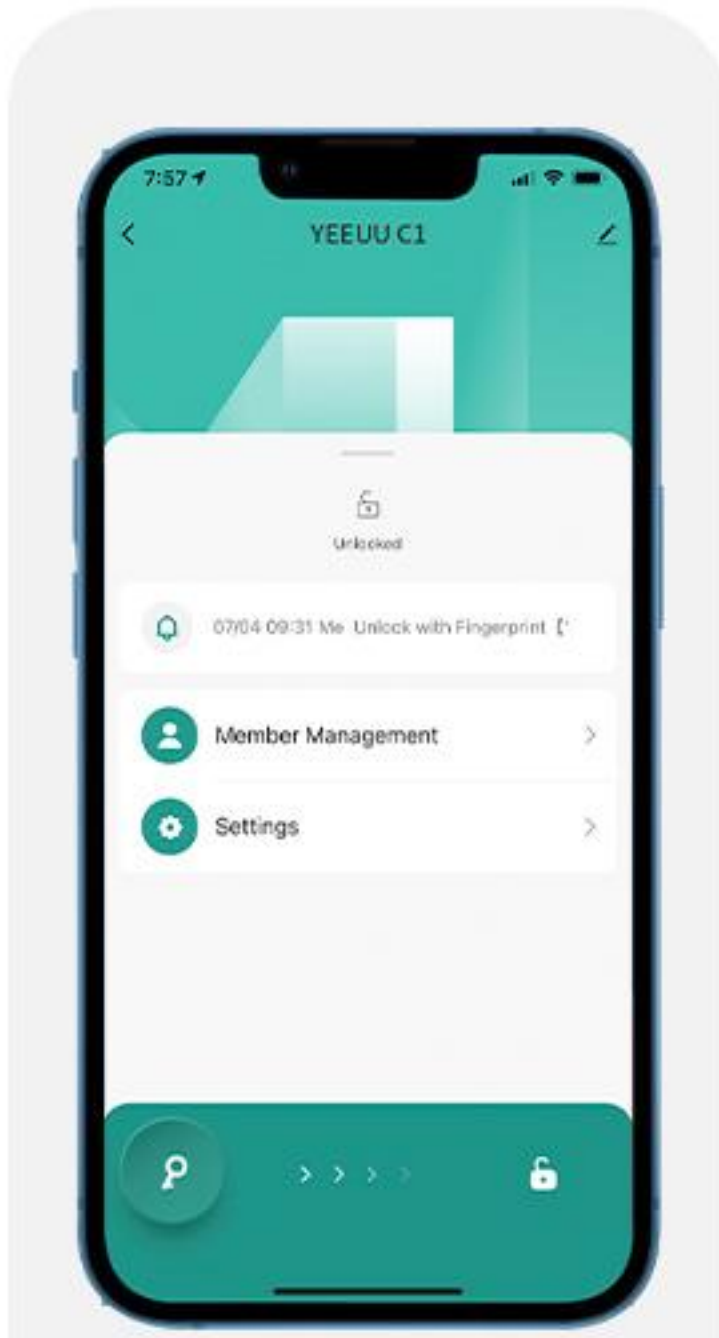
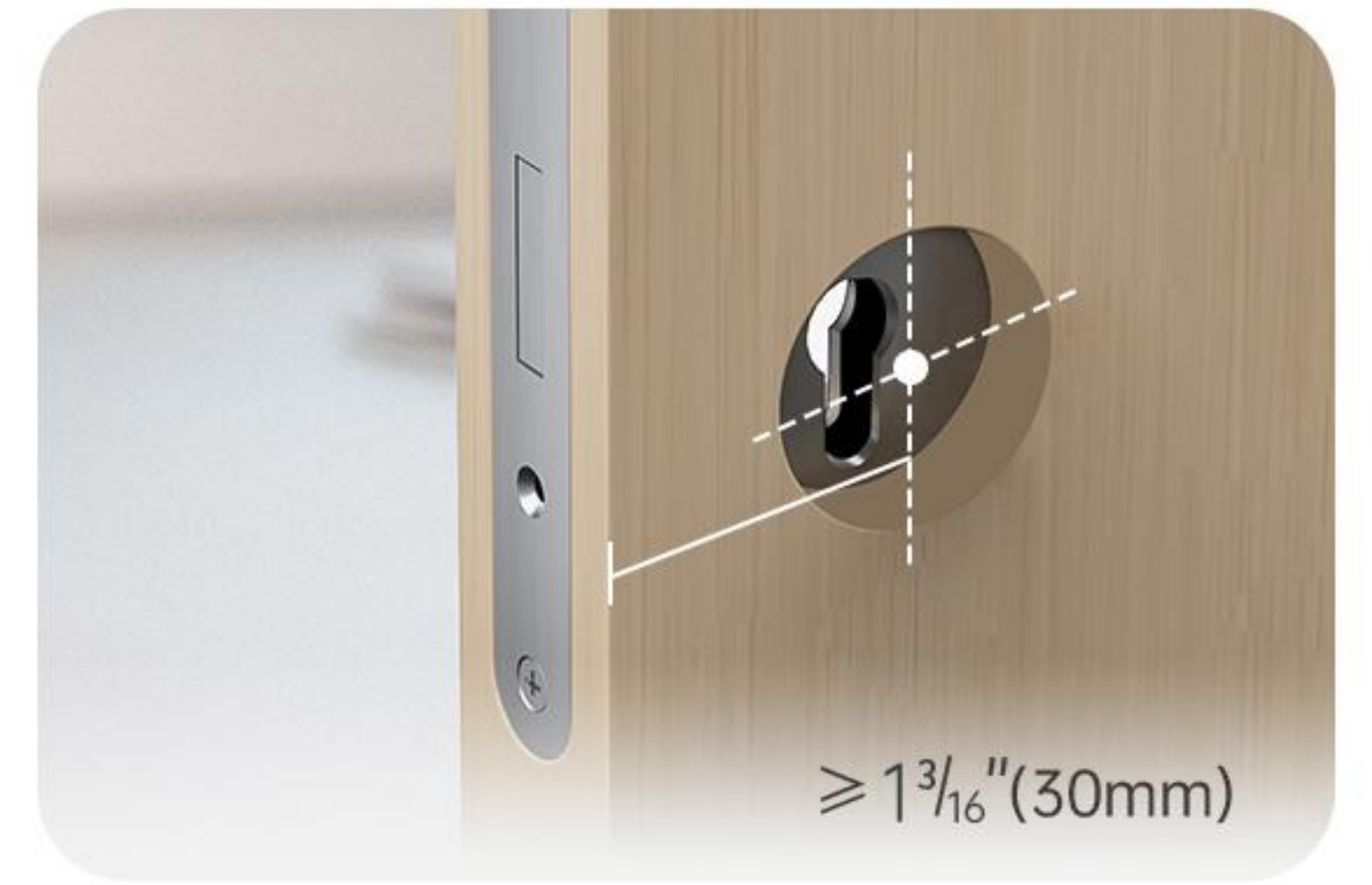
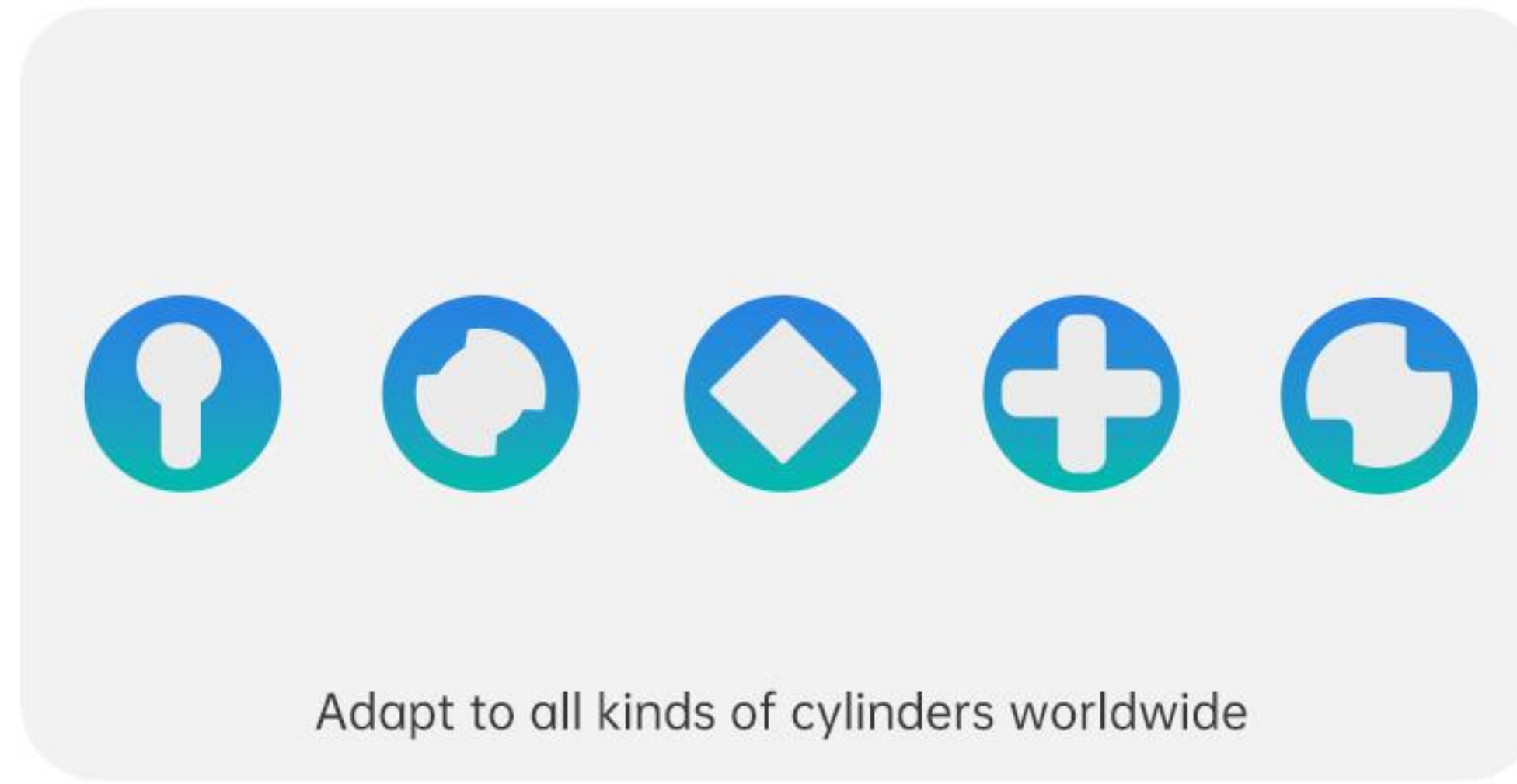

One Step to Lock

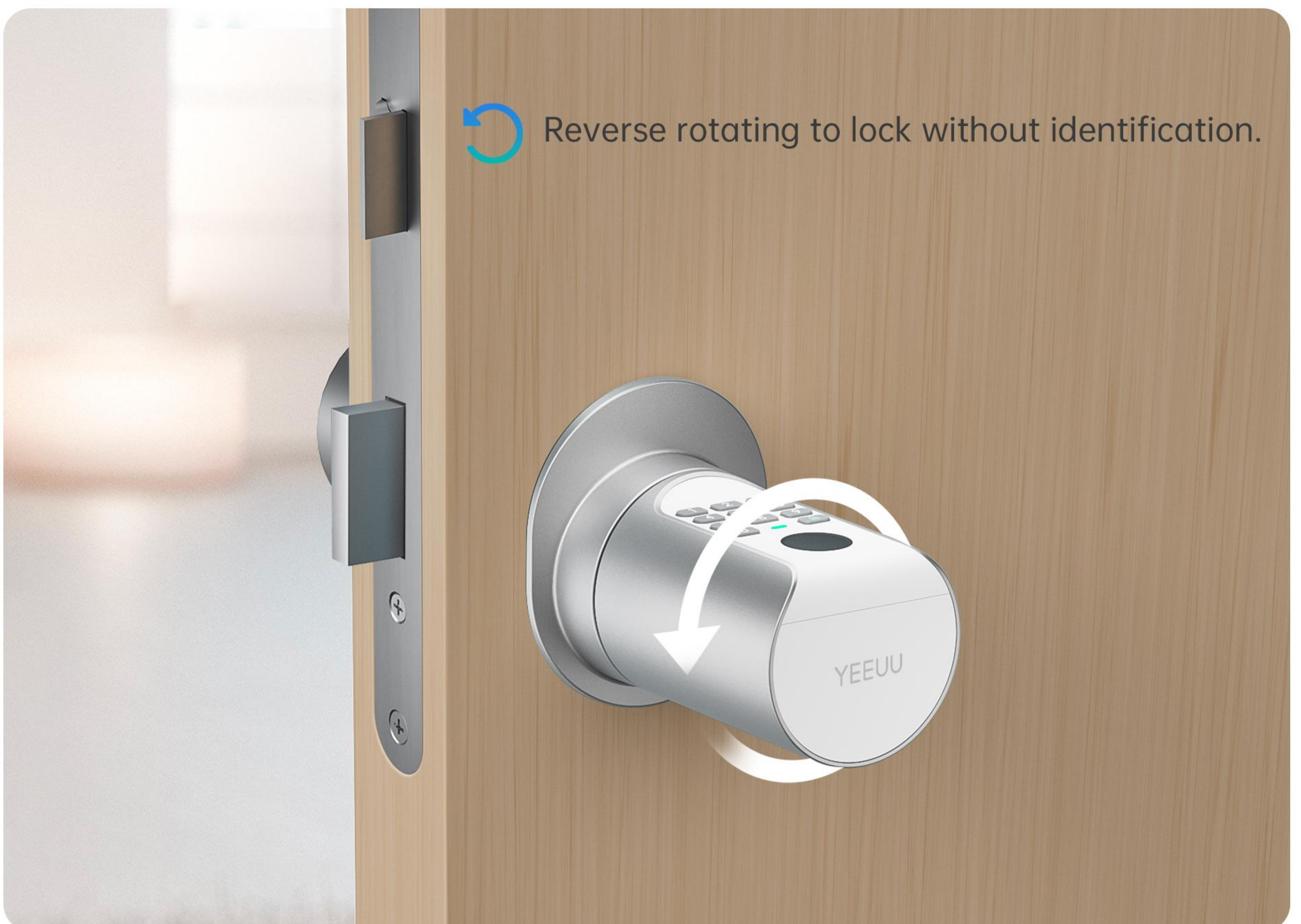

Installation Adaptation

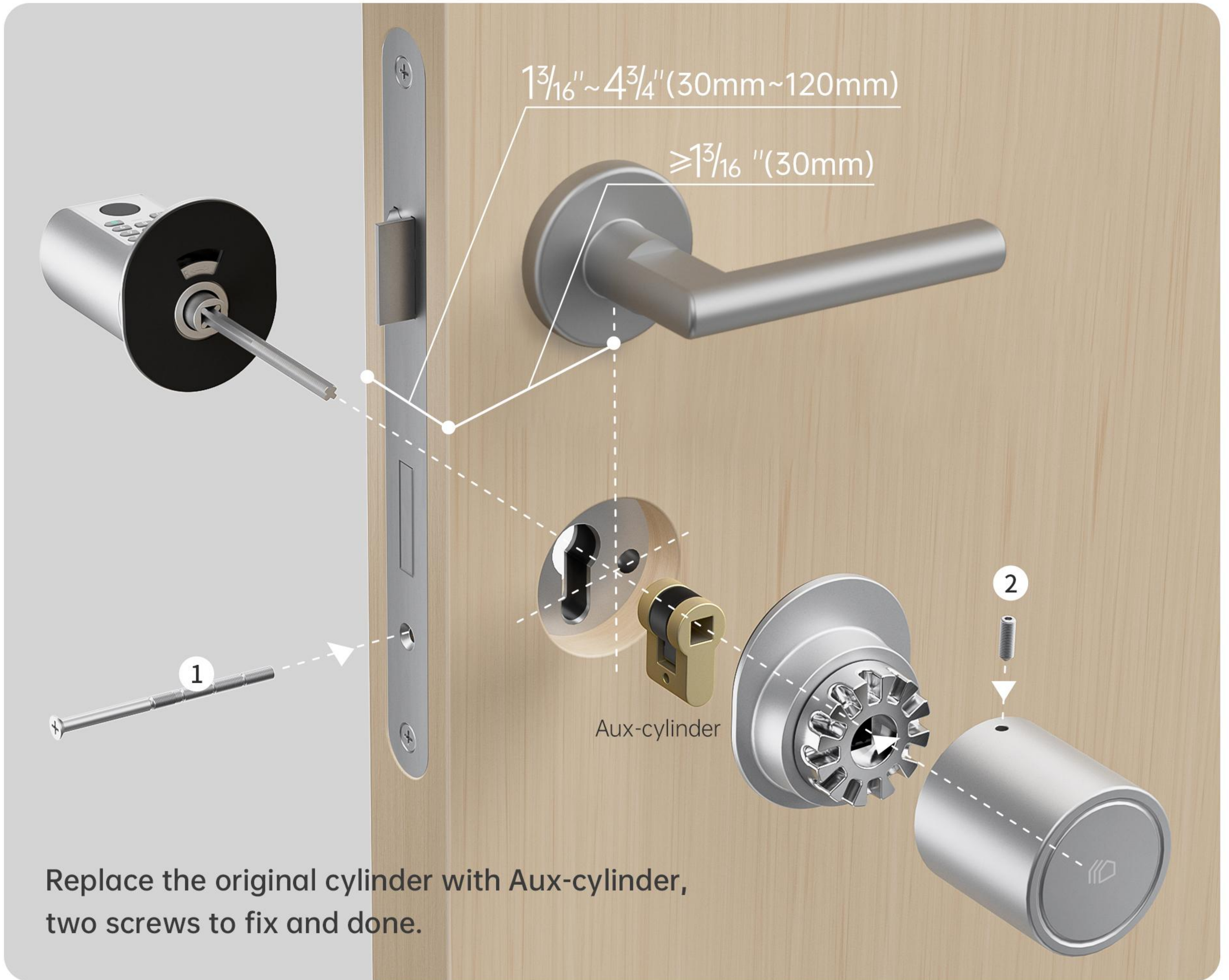

Adapt to the locks without Aux-cylinder as shown.



Adapt to a wide range of door thickness and always against doors.



Adapt to the backset $\geq 30\text{mm}$

Installation Form

It can be installed in various mechanical locks.



Power Parameters



18^{Months}

4*AAA Alkaline Batteries (LR03)

*Unlock 10 times a Day

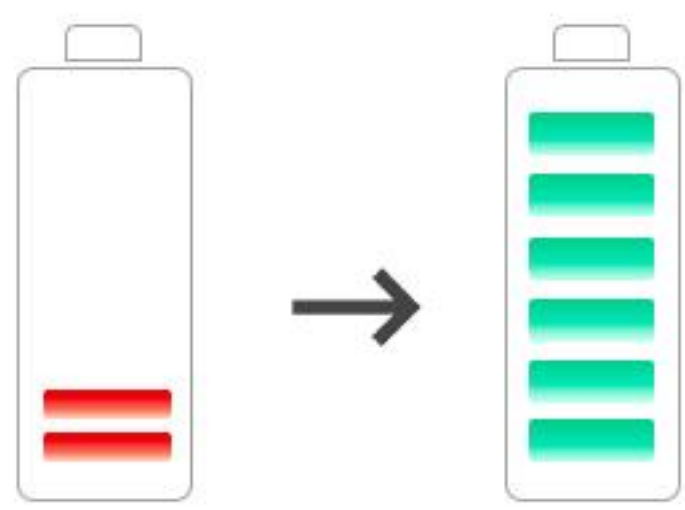

Easy to Replace Batteries

Unscrewing the front lock's battery cover to replace batteries.

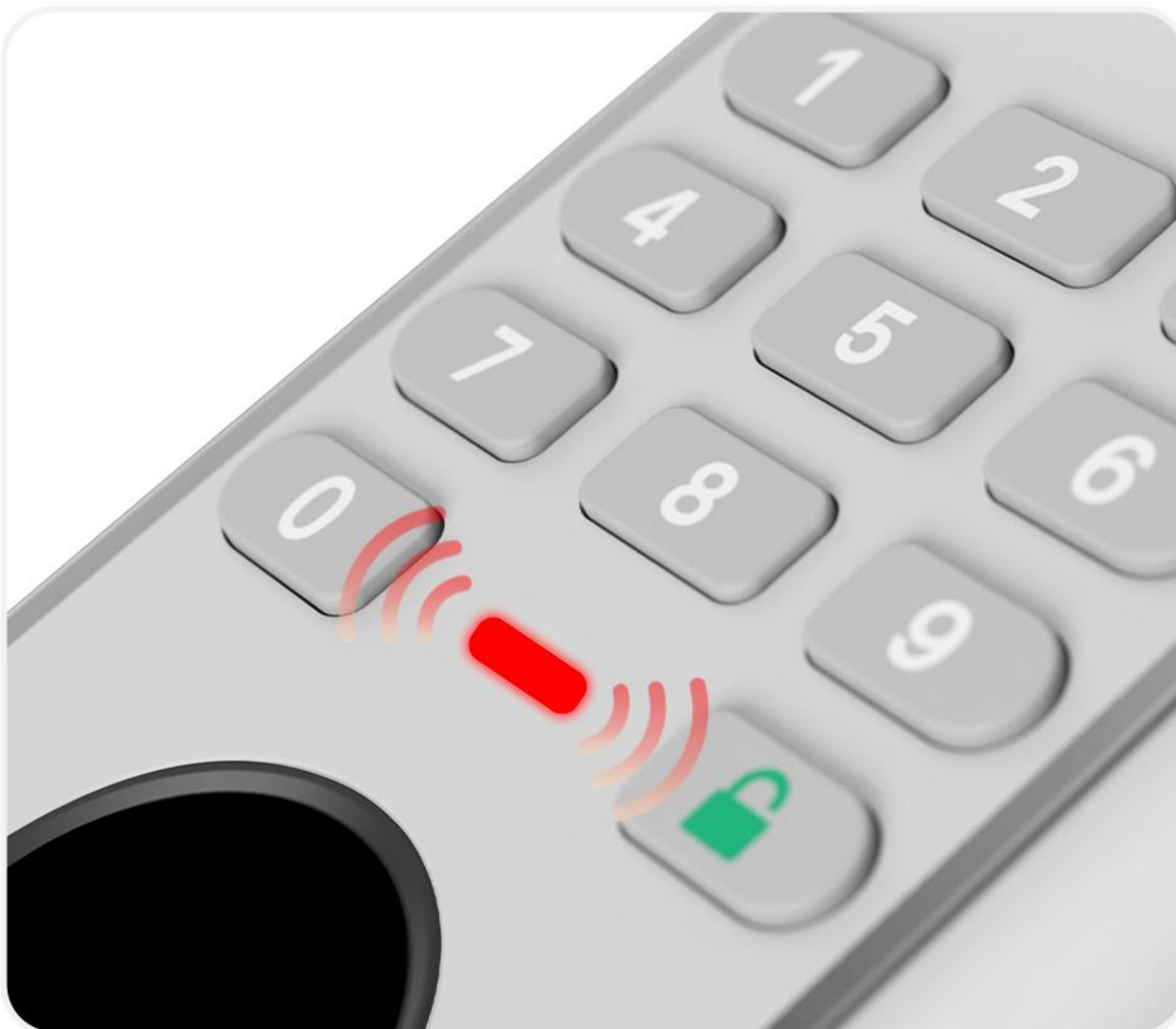

Low Battery Alarm

Intuitive acousto-optic alert to remind.
Get real-time notifications remotely with Wi-Fi bridge.

IPX5

Waterproof and Rain-proof

Multiple silicone parts inside ensure water-resistant.

IPX5 water-resistant provided by authority organization.

Suitable for outdoor environments, even rain.



Fingerprint Access



Advanced Semiconductor
Fingerprint Identification

0.5s

0.5-second Dramatic
Identification

360°

360-degree
Identification

50PCS

Storage of
50 Fingerprints

Fingerprinter Security

All fingerprint data are stored in lock itself.

The App complies with GDPR/CCPA Standards and be provided by authority organization.



High-quality MCU, stable performance.

**Nordic
52832**



Code Access

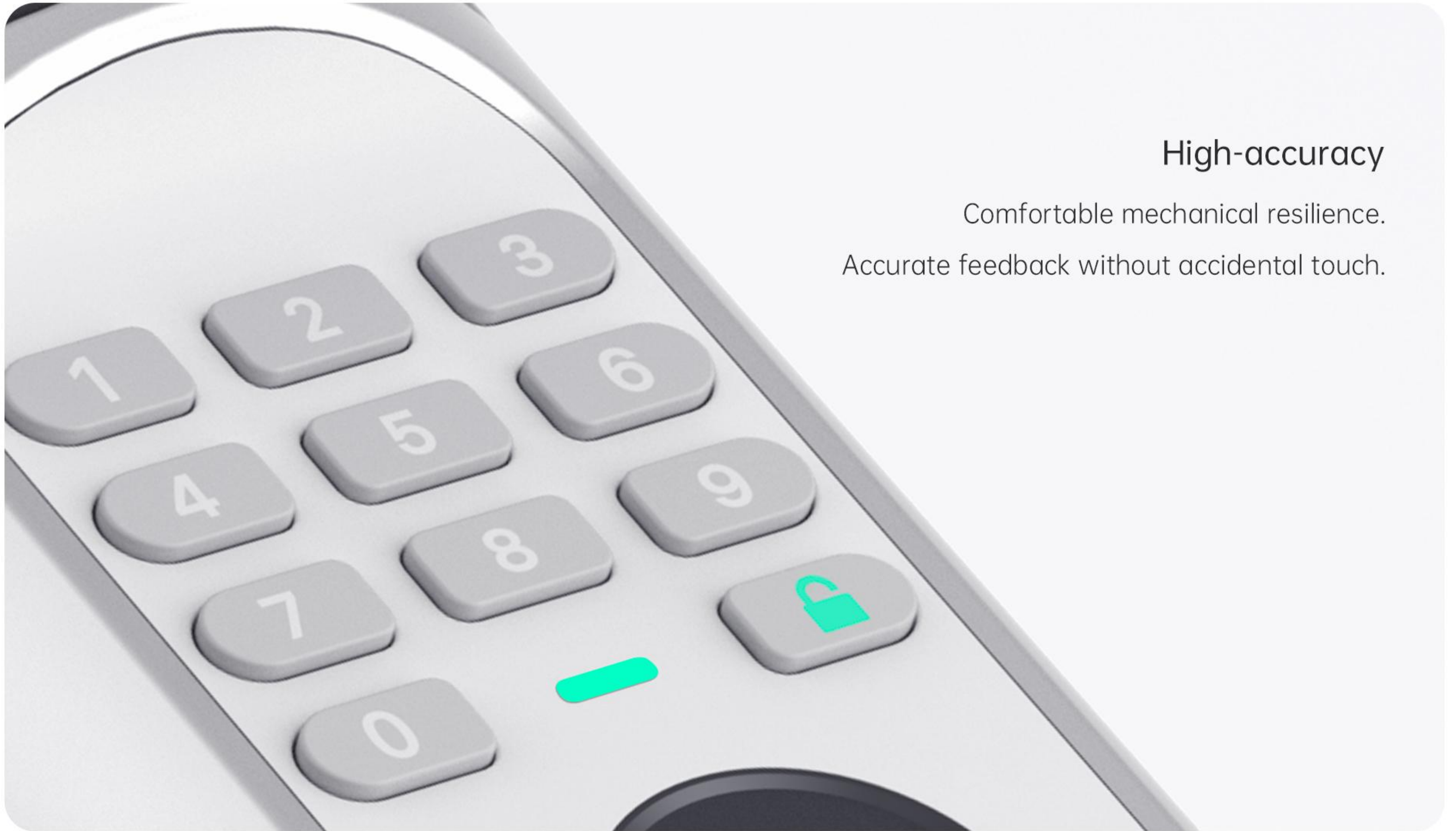

High-accuracy

Comfortable mechanical resilience.
Accurate feedback without accidental touch.

Anti-peep Code

Prevent leakage of personal code.

0088 **058846** 0825

Anti-peep Code **Correct Code** Anti-peep Code



Temporary Code

Setting start and end time.



Recurring Code

Taking effect periodically.



Dynamic Code

Changing every 5 minutes.



Off-line Code

Manage without relying on the network.

Remote Access

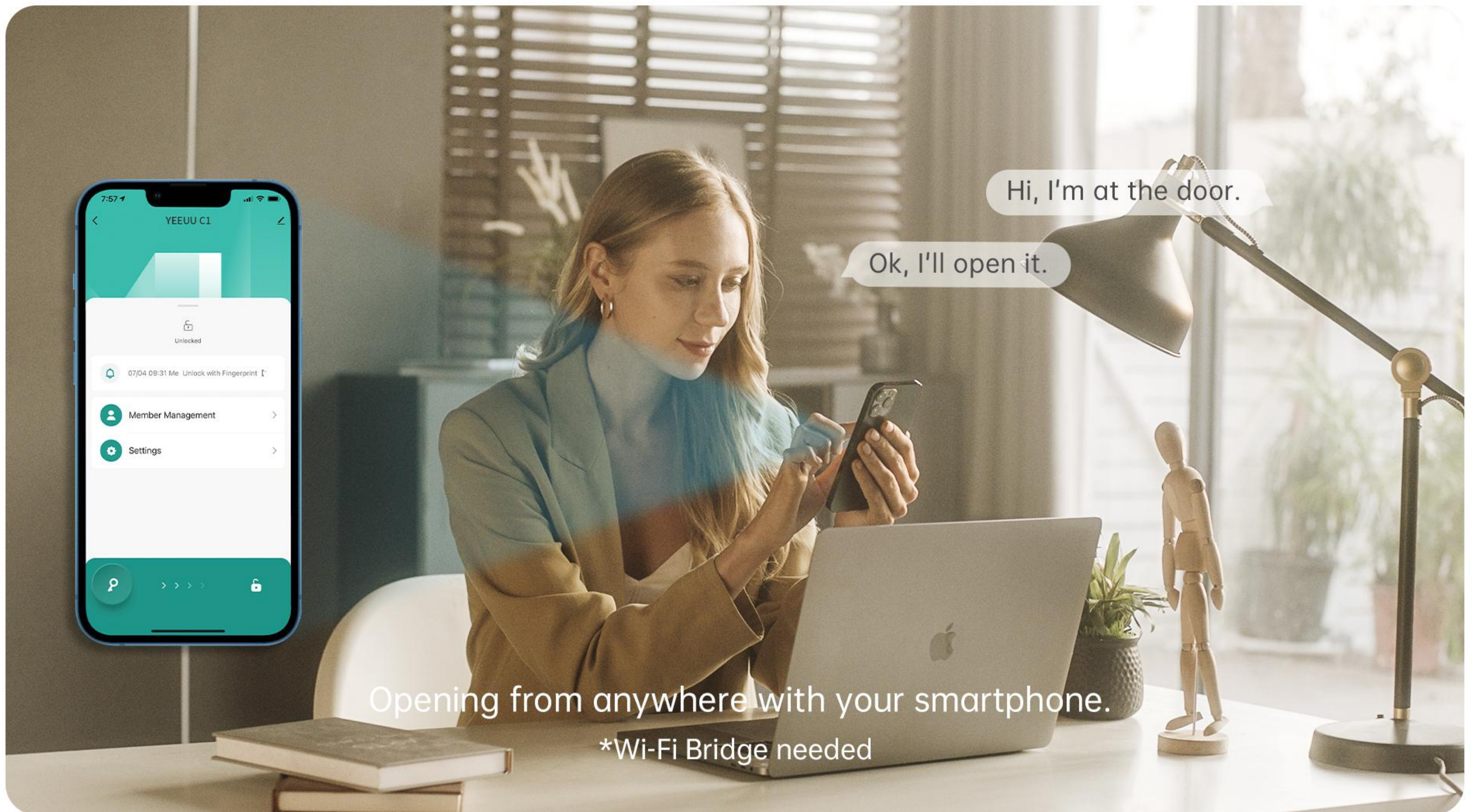

Emergency Key Access

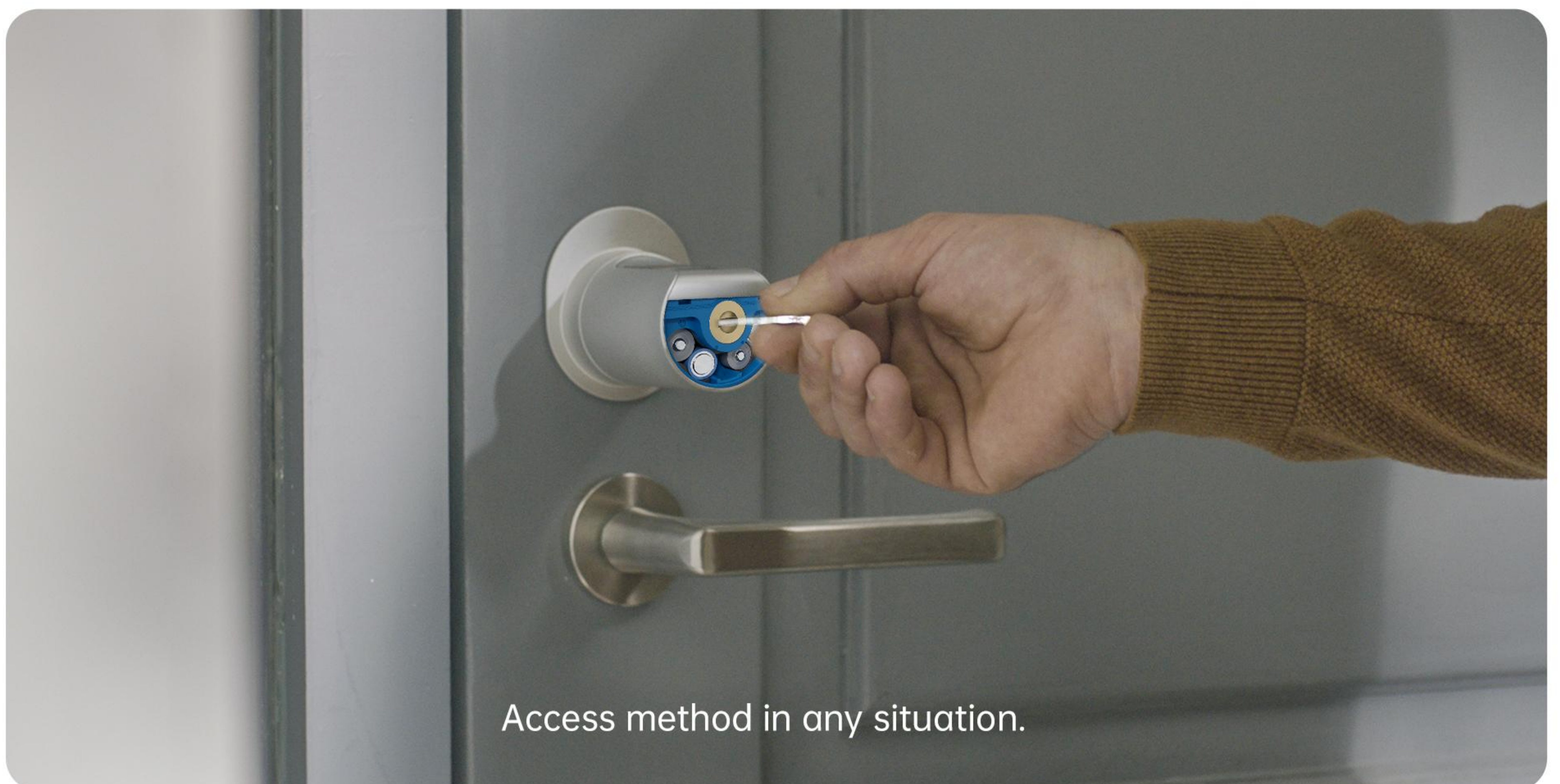

Voice Access

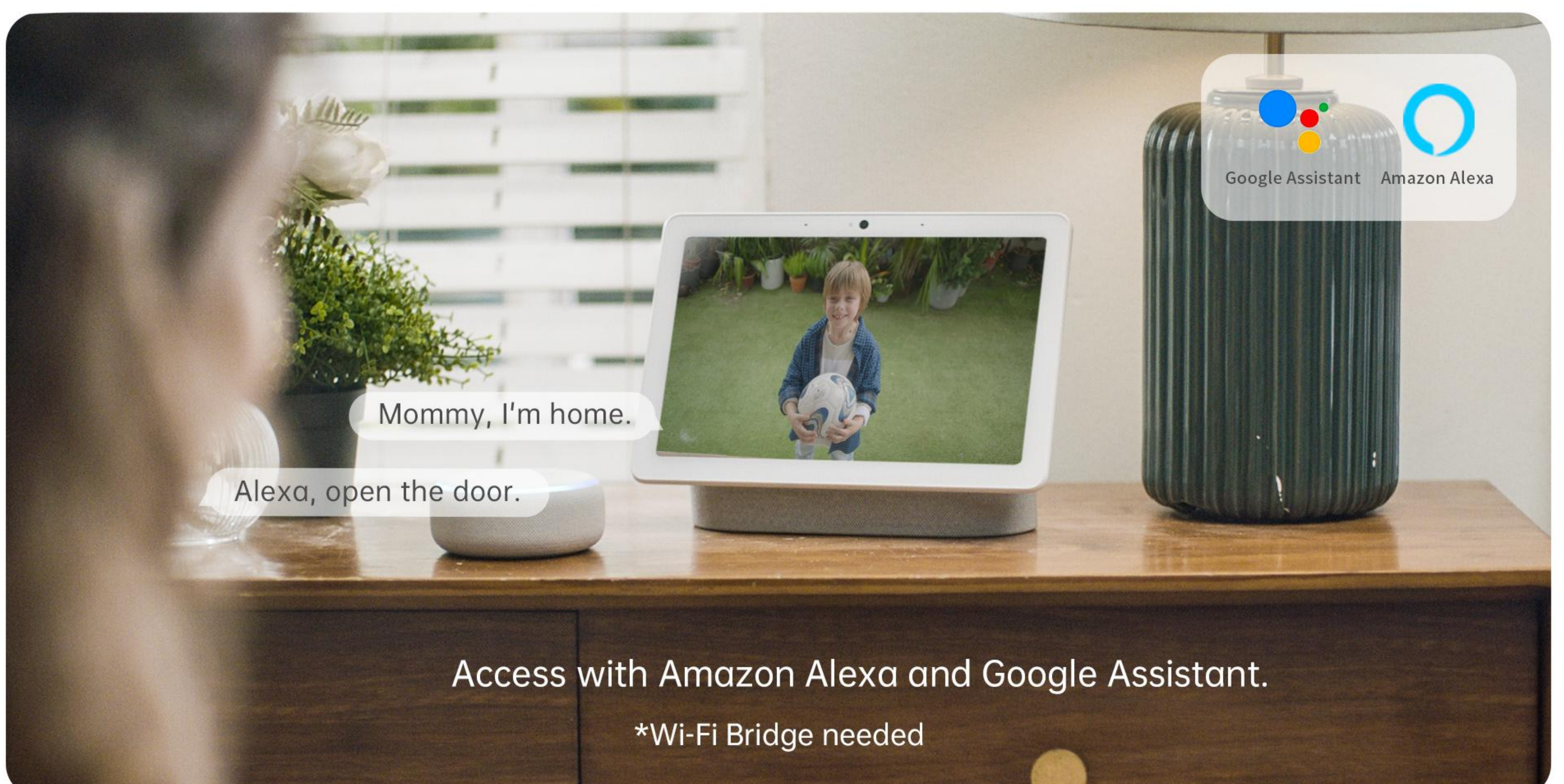

In-app Management

Grand Management



Semiconductor
Fingerprint

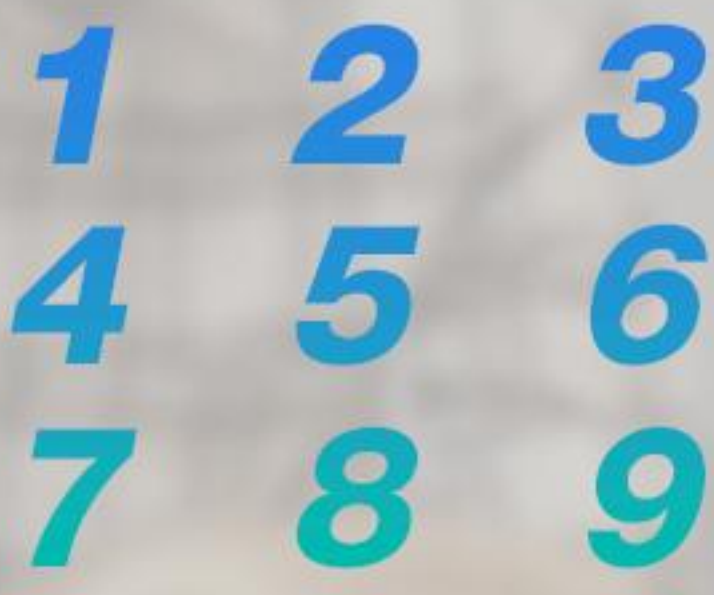

Multiple Access
Methods



NFC Tag Access

View Opening Records

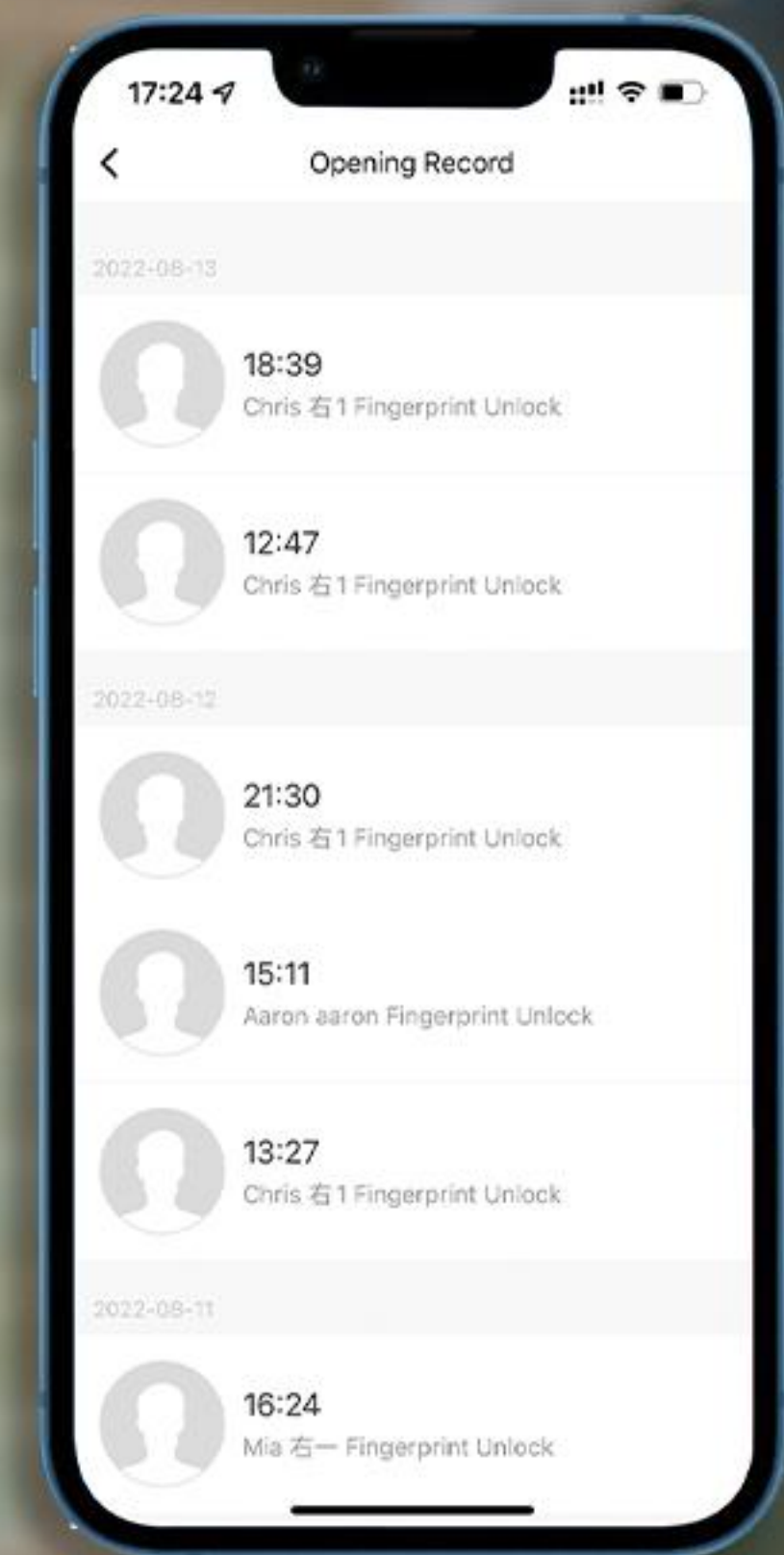

Synchronized opening records

Get Real-time Notifications Remote Receiving



Low Battery Alarm



Opening Records



Abnormal Alarm

YEEUU

Safety & Reliability





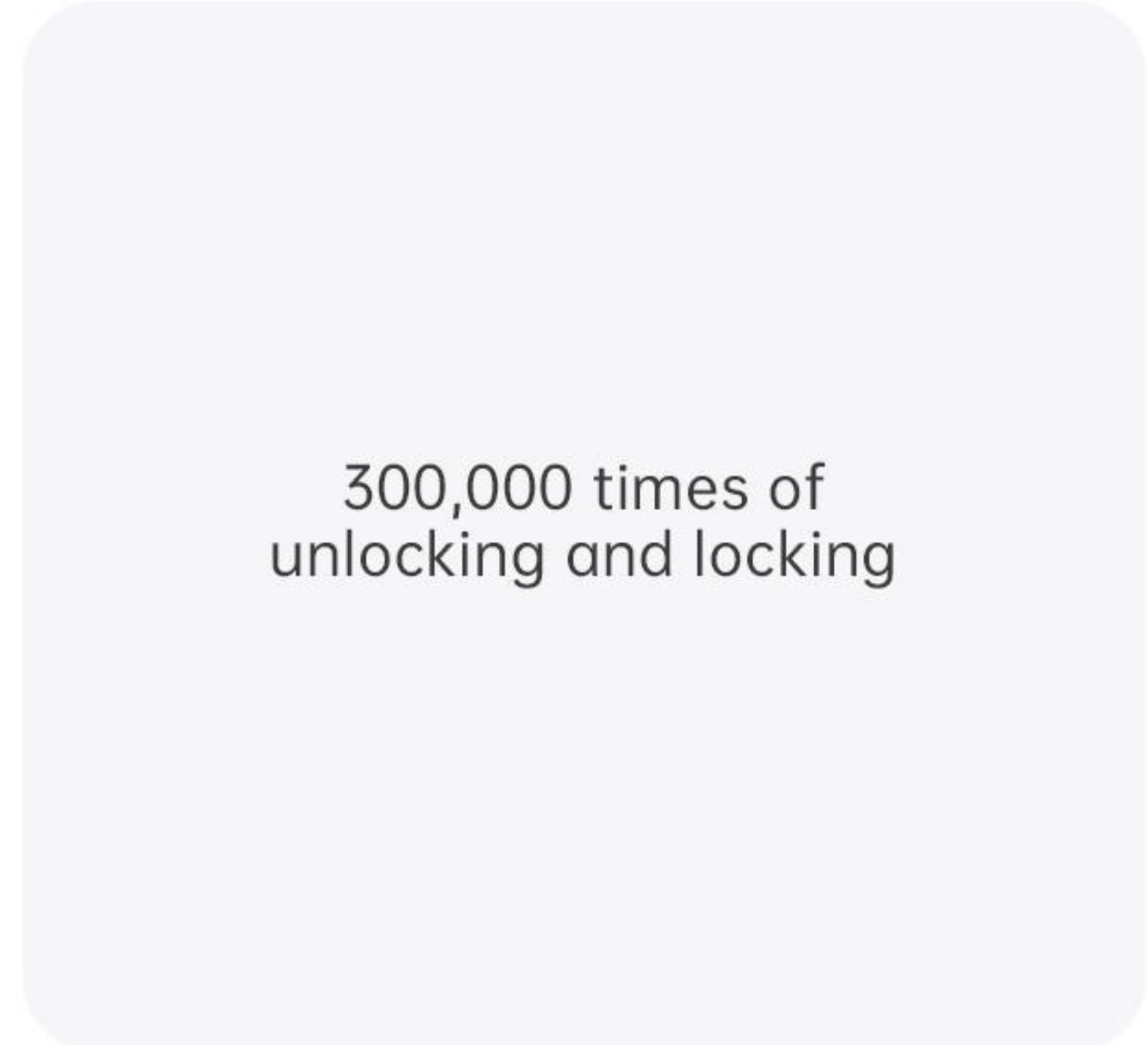
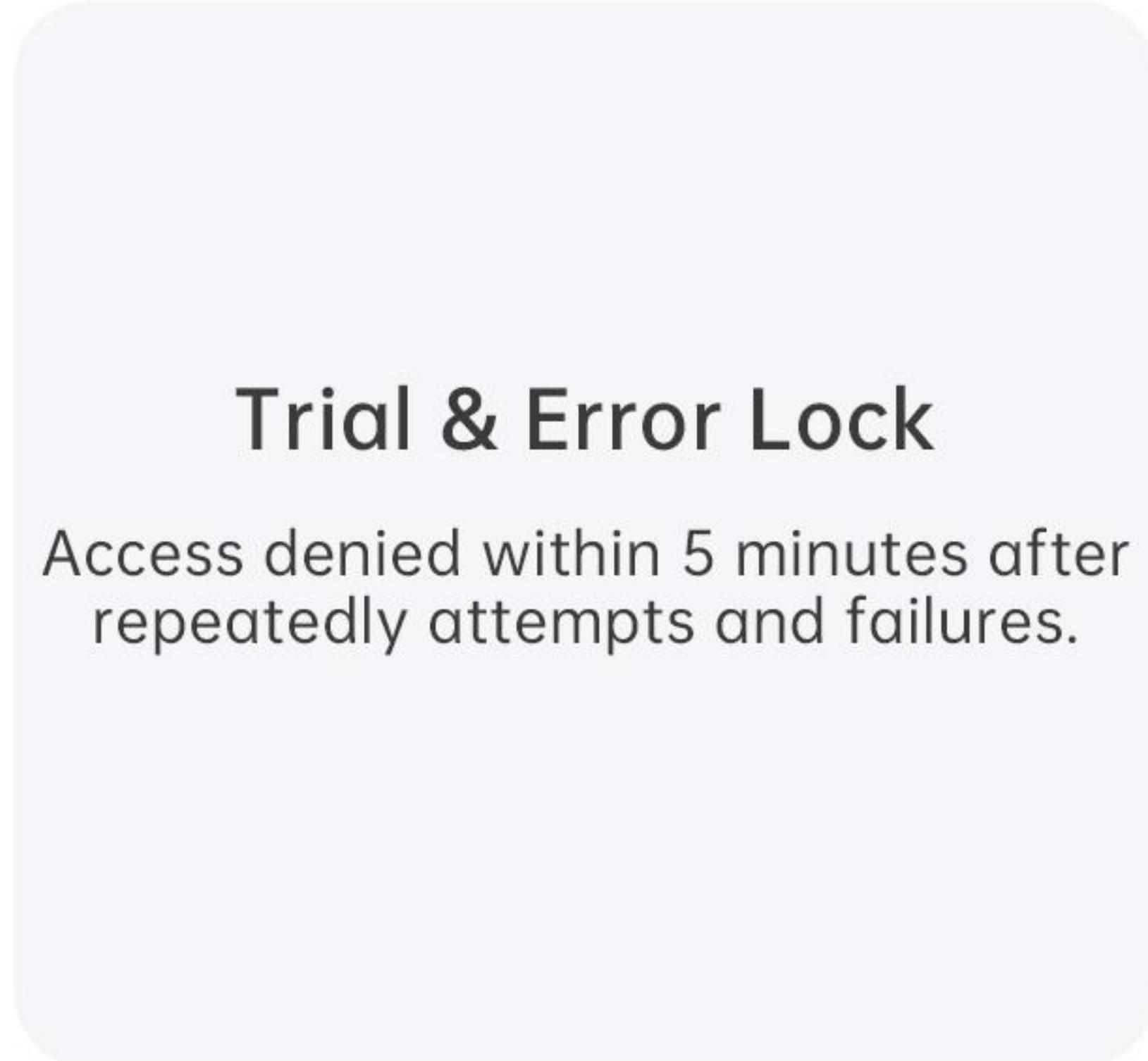

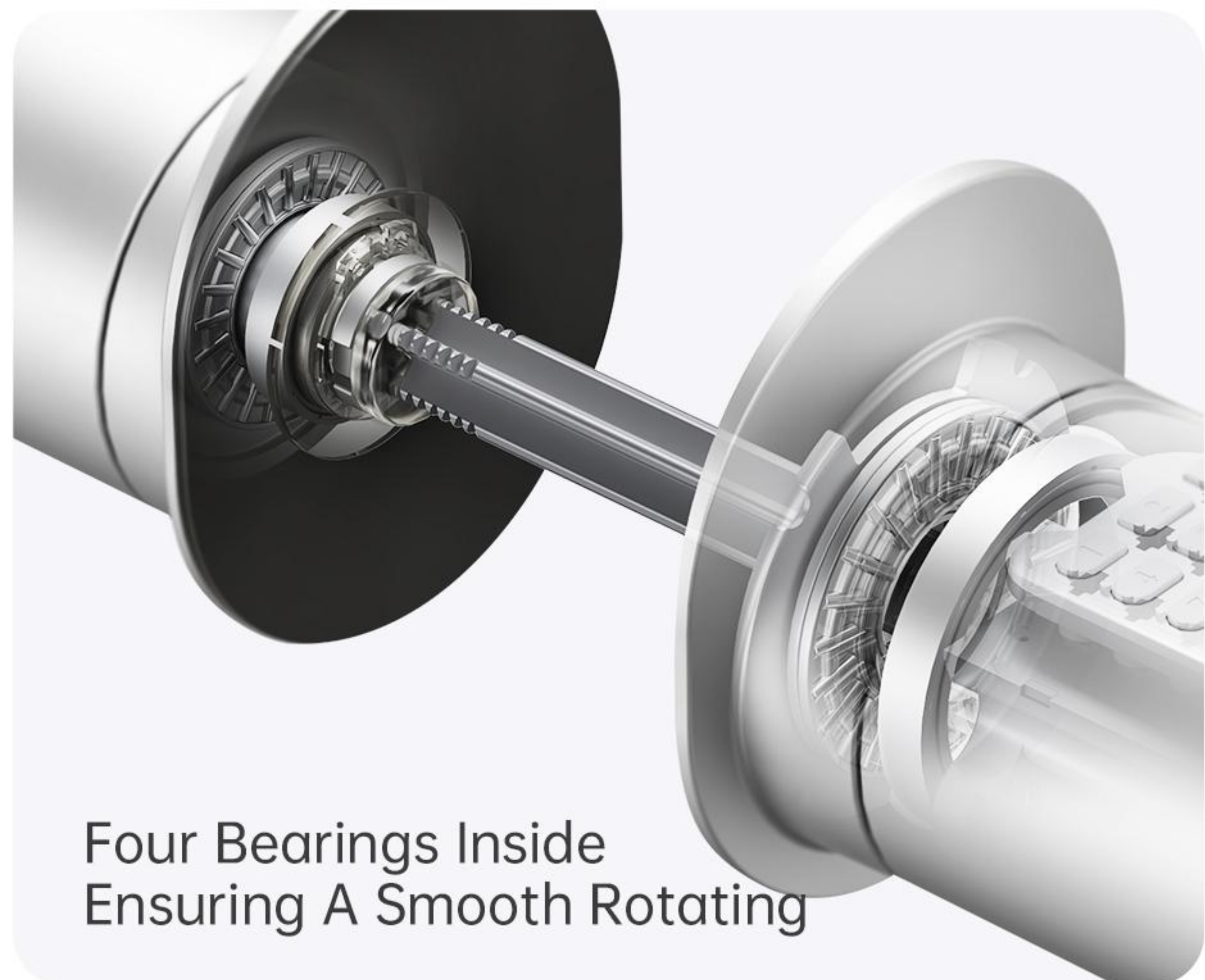
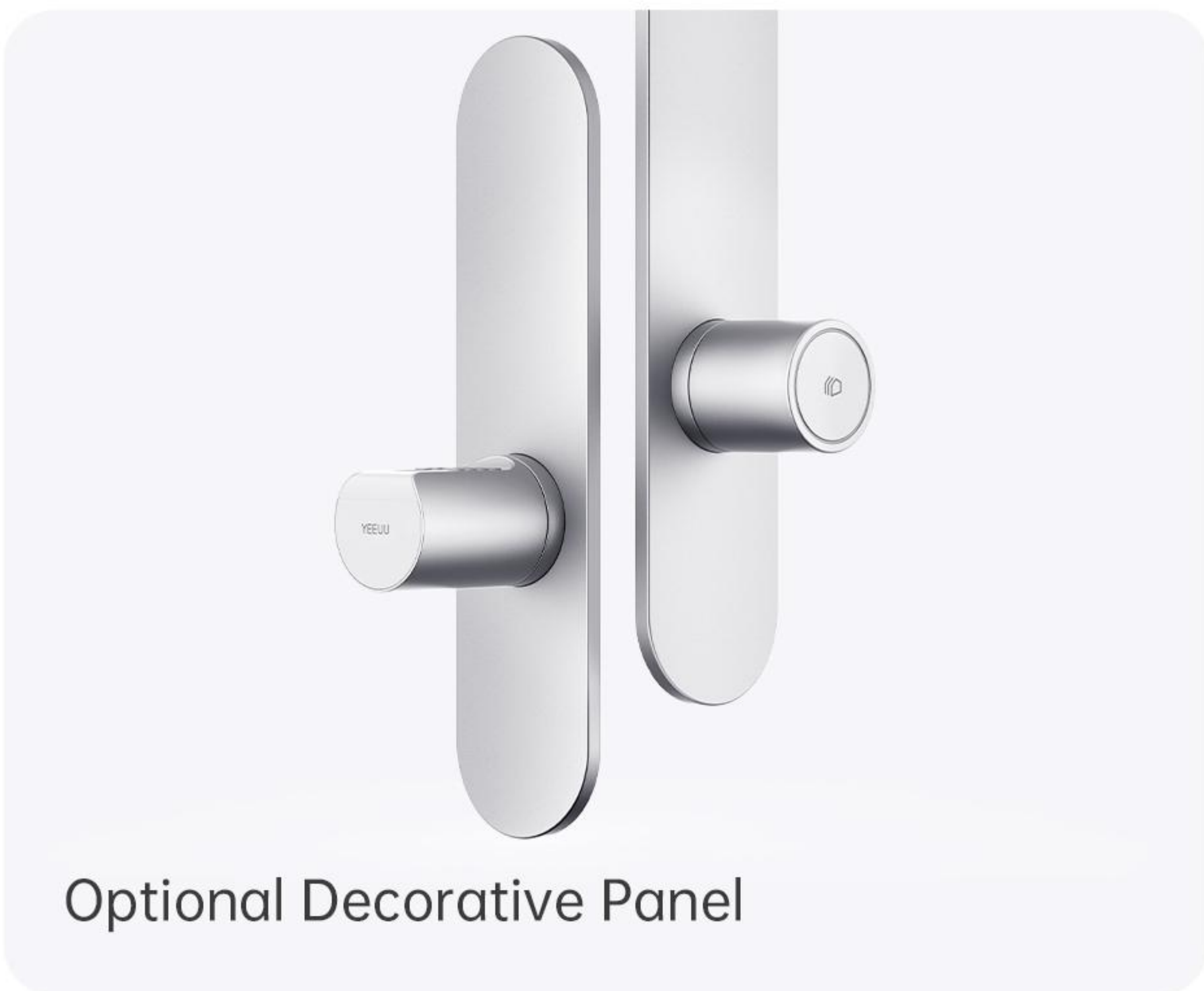
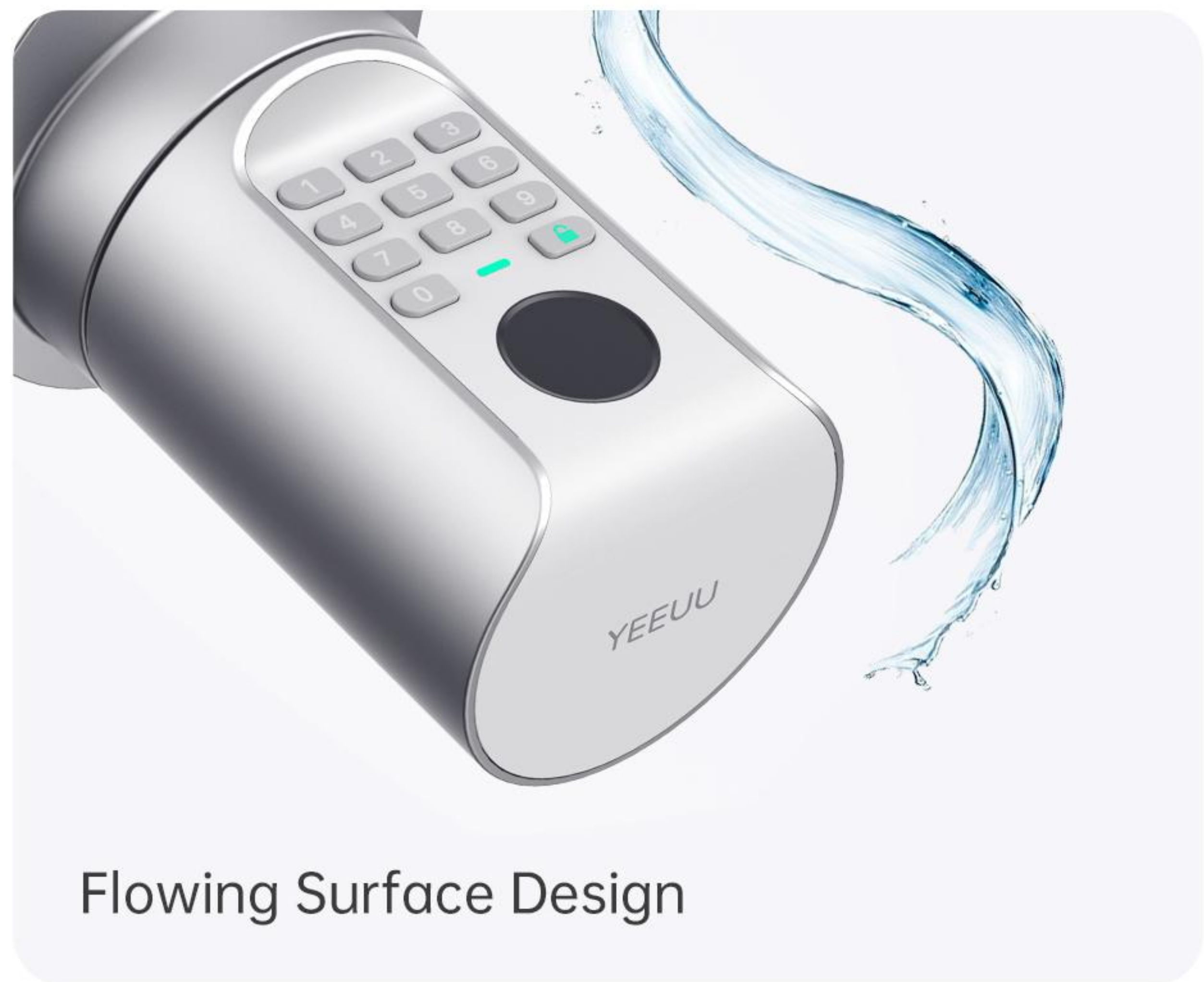
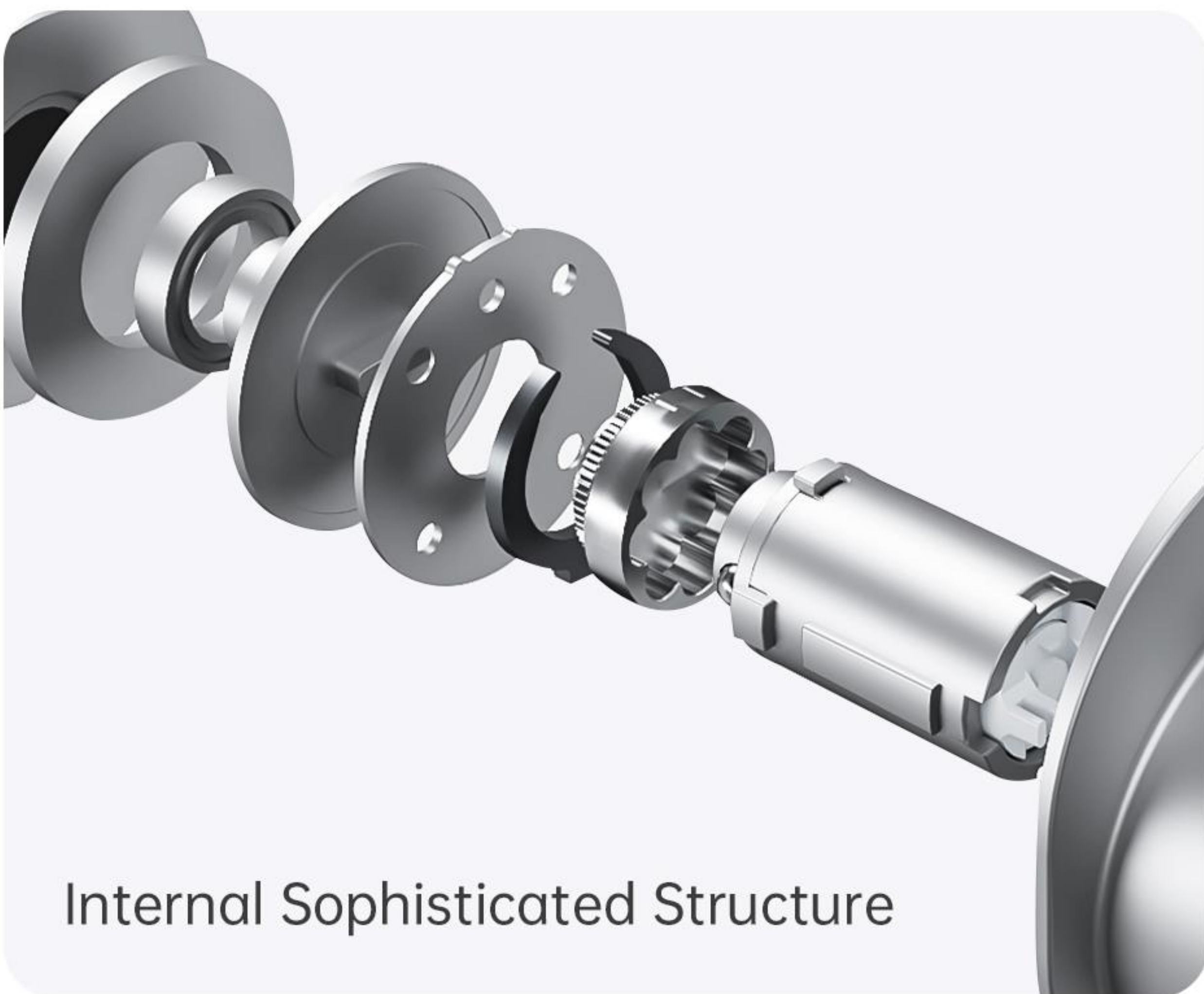

Stainless steel spindle

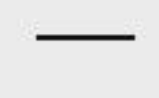

Design Display



Contrasting Model Specification

 <p>C160E</p>		 <p>Code Access</p>	 <p>NFC Mobile Keys Access</p>
 <p>C170E</p>	 <p>Fingerprint Access</p>	 <p>Code Access</p>	 <p>NFC Mobile Keys Access</p>

Packing List



YEEUU App Function

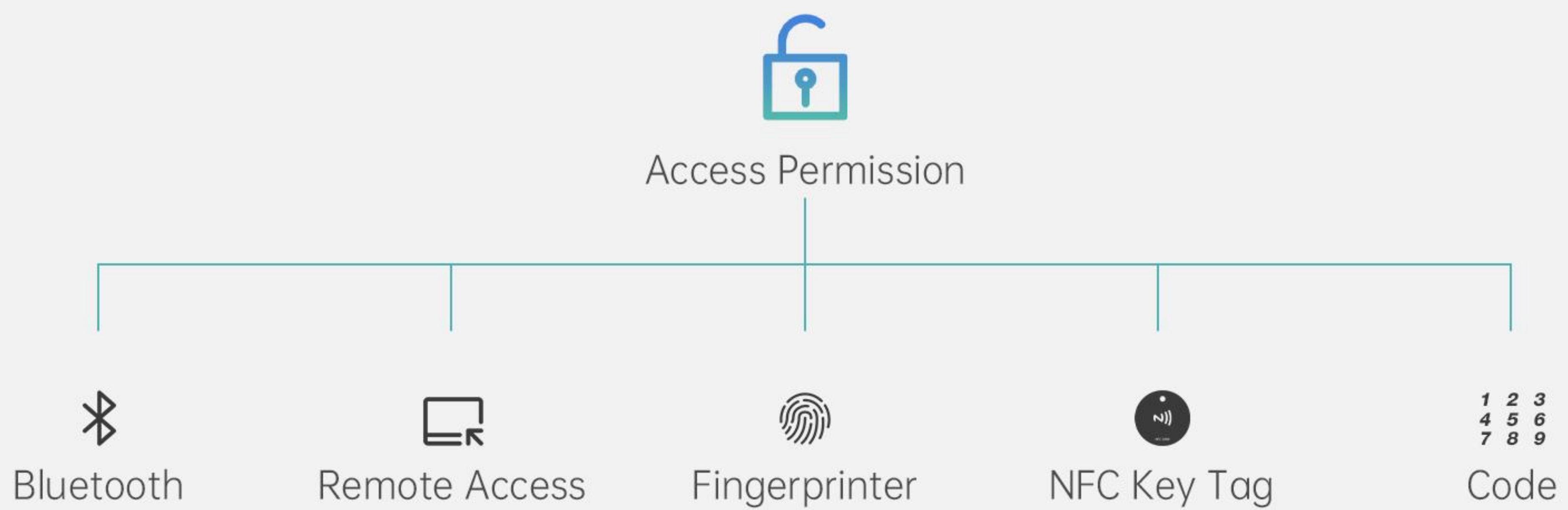
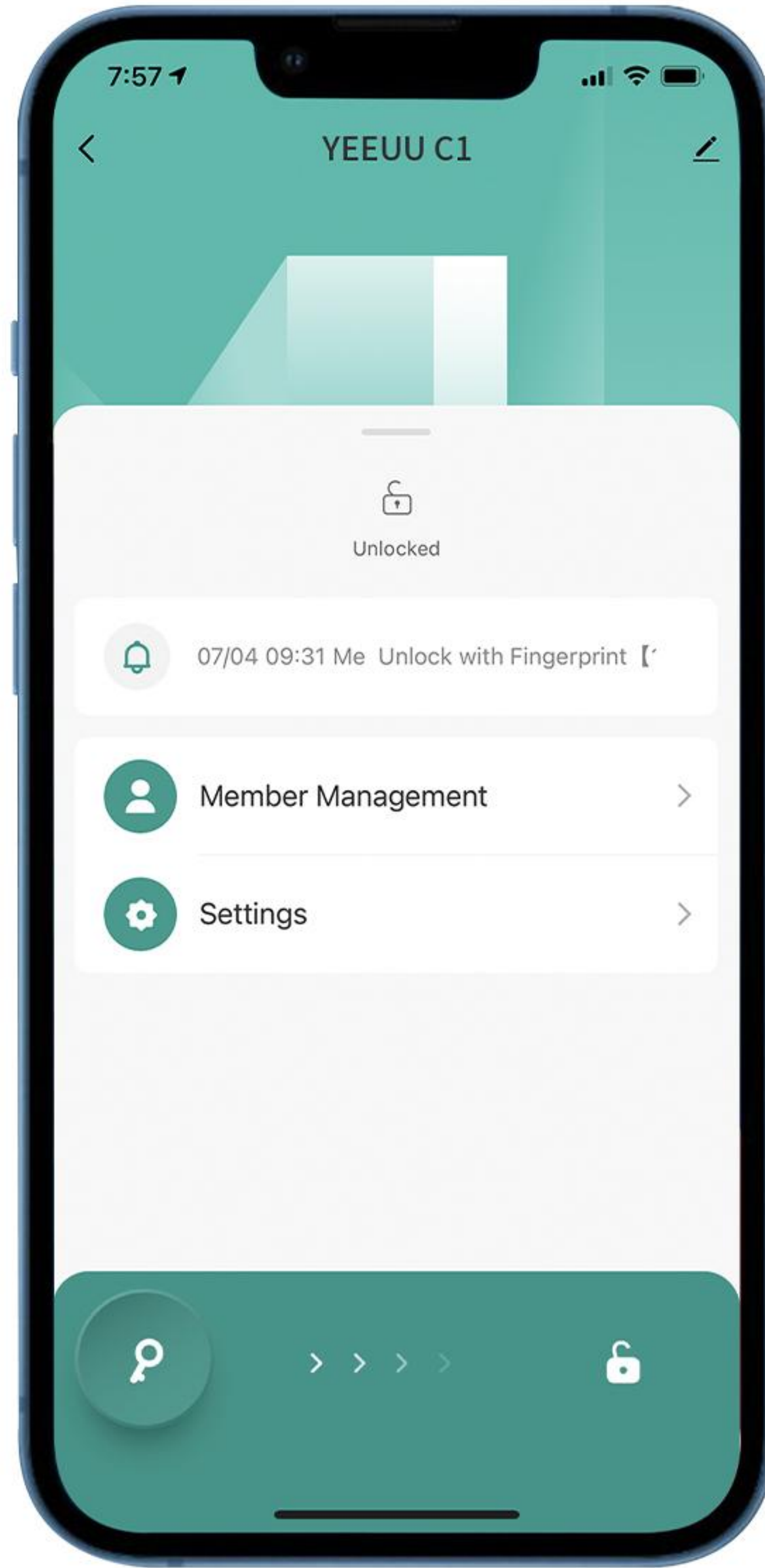

Firmware Update

Query Records

Information Push System

Sharing Scheme

Dimension Wireframe

